



*Sidoti & Company*

January 13, 2014



VEHICLE ACCESS SYSTEMS TECHNOLOGY



WITTE • STRATTEC • ADAC

Patrick J. Hansen

Senior Vice President & CFO

## Disclosure for Presentation for Sidoti

This presentation contains “forward-looking statements” within the meaning of the Private Securities Litigation Reform Act of 1995. These statements may include expected future financial results, product offerings, global expansion, liquidity needs, financing ability, planned capital expenditures, management’s or the Company’s expectations and beliefs, and similar matters. The Company’s business, operations and financial performance are subject to certain risks and uncertainties, which could result in material differences in actual results from the Company’s current expectations. These risks and uncertainties include, but are not limited to, general economic conditions, in particular, relating to the automotive industry, customer demand for the Company’s and its customer’s products, competitive and technological developments, customer purchasing actions, foreign currency fluctuations and costs of operations. Such risks and uncertainties are discussed further in the Company’s filings with the Securities and Exchange Commission.

This presentation includes selected information regarding the Company’s business, operations and financial performance and is qualified in its entirety by the more complete information contained in the Company’s filings with the Securities and Exchange Commission and other public disclosures.

All information in this presentation is as of January 13, 2014 and any distribution of this presentation after that date is not intended and will not be construed as updating or confirming such information. The company undertakes no obligation to update any information in this presentation to reflect subsequent events or circumstances.

This presentation can be found at:  
[www.strattec.com](http://www.strattec.com)  
Investor Relations  
Presentations

# 1<sup>st</sup> Quarter, FY '14 Results

(000's except per share amounts )



	<b>September <u>2013</u></b>	<b>September <u>2012</u></b>
<b>Net Sales</b>	<b>\$ 79,595</b>	<b>\$ 70,807</b>
<b>Gross Profit</b>	<b>\$ 14,515 18.2%</b>	<b>\$ 13,713 19.4%</b>
<b>Operating Expenses</b>	<b>\$ 9,470 11.9%</b>	<b>\$ 9,120 12.9%</b>
<b>Net Income</b>	<b>\$ 3,211</b>	<b>\$ 2,670</b>
<b>Diluted Earnings Per Share</b>	<b>\$ .91</b>	<b>\$ .78</b>



VEHICLE ACCESS SYSTEMS TECHNOLOGY



- Based on current customer orders we anticipate approximately \$80 million in sales in our second quarter compared to \$72.2 million in the prior year quarter.
- Capital spending will be in the \$9 - 10 million range during fiscal year 2014.
- STRATTEC Defined Benefit Pension Plan was frozen effective December 31, 2009. Anticipate Plan contributions in fiscal 2014 of \$3.0 million which is consistent with fiscal 2013.

	<b>June 30</b>	<b>June 30</b>
	<b><u>2013</u></b>	<b><u>2012</u></b>
Plan Benefit Obligation	\$89.9	\$103.4
Plan Assets	<u>\$90.4</u>	<u>\$79.5</u>
Over (Under) Funded Status	\$.5	(\$23.9)

- As of September 30, 2013, the Company had in excess of \$12 million of cash or \$4/share and anticipated funding the above requirements primarily from current operating cash flows.
- We have \$30 million of credit facilities available with BMO Harris Bank with current borrowings outstanding of \$3.0 million.
- Increased dividend 10% during the 1<sup>st</sup> Quarter ending September 2013 and stock price increase of 73% in last 12 months

- **AWARD**
  - Chrysler Supplier of the Year in Electronics



- **Diversification**

- Bridgewood Advisors searching for acquisitions and partnerships
- Security Products
- Motion Control Products
- Vertical Integration along with market diversification
- Aftermarket
- Strattec Component Solutions (Zinc diecast contract manufacturing)

- **Growth Initiatives**

- Door Handles – both in China and Mexico
- Expansion of Mexican Plant
- Tier II to Maserati on Key Fob's
- Dealer Direct – Cut Key Program
- Acquisition of NextLock





- Biometric Security
- New product available in June 2014
- Target residential and commercial markets
- Build in Strattec Mexican facilities opens US government market
- Cross fertilize technology for automotive

# Product and Sales Information

## 2001

### Keys & Locksets

- Mechanical keys
- Mechanical keys w/ electronic security enhancements
- Ignition locks
- Door locks
- Rear compartment locks
- Glove box locks
- Accessory locks

### Driver Controls

- Steering column mounted ignition lock housings

### Miscellaneous Industrial

- Zinc die-castings

## 2013

### All the products in place in 2001, plus

#### Keys & Locksets

- Electro-mechanical entry keys w/remote entry electronics
- Bladeless electronic keys
- Electronic remote entry key fobs
- Codeable locks
- Biometric locks

#### Driver Controls

- Instrument panel mounted ignition lock housings
- Instrument panel docking receivers for bladeless electronic keys
- Instrument panel "Push to Start" ignition switches for passive security systems

#### Latches

- Rear compartment (tailgate, liftgate, trunk lid)
- Seat Back

#### Power Access

- Power sliding side door systems
- Power liftgate
- Power trunk lid
- Power cinching latches & strikers
- Electronic control modules

#### Door Handles & Functional Exterior Trim

- Inside and outside handles
- Outside handle chassis
- Rear license plate light bars with park assist cameras and/or concealed switches for releasing rear compartment latches

#### Miscellaneous Industrial

- **i-Guard** electronic vehicular access systems

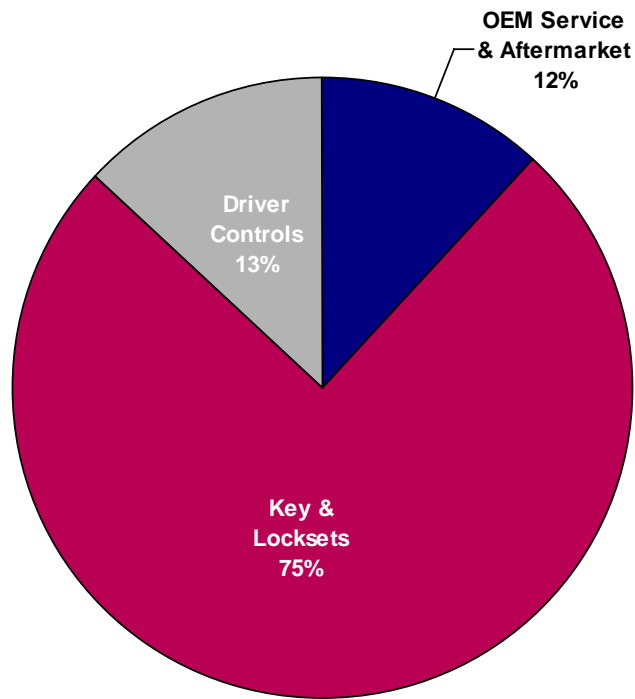

**Fiscal Year 2001**  
**Net Sales = \$203 million**

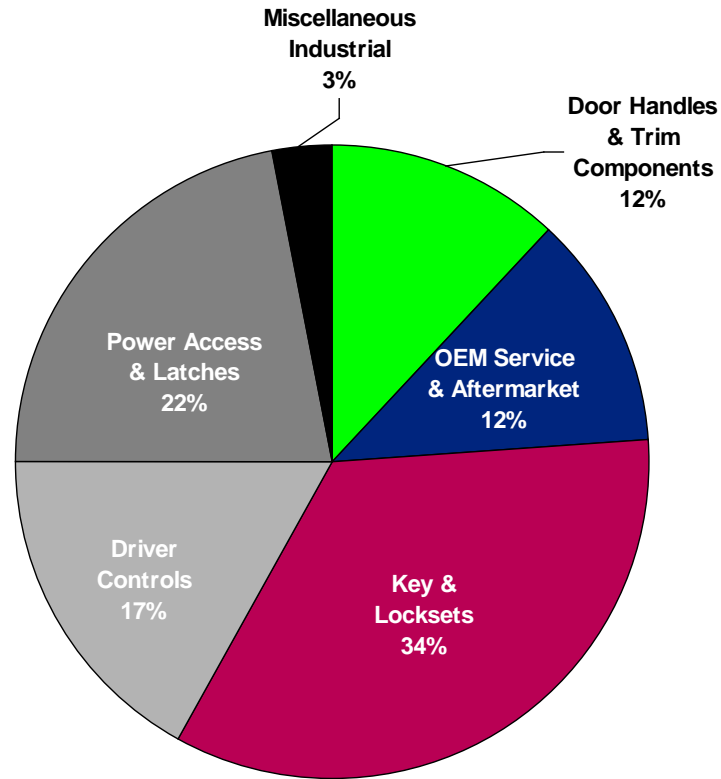

**Fiscal Year 2013**  
**Net Sales = \$298 million**

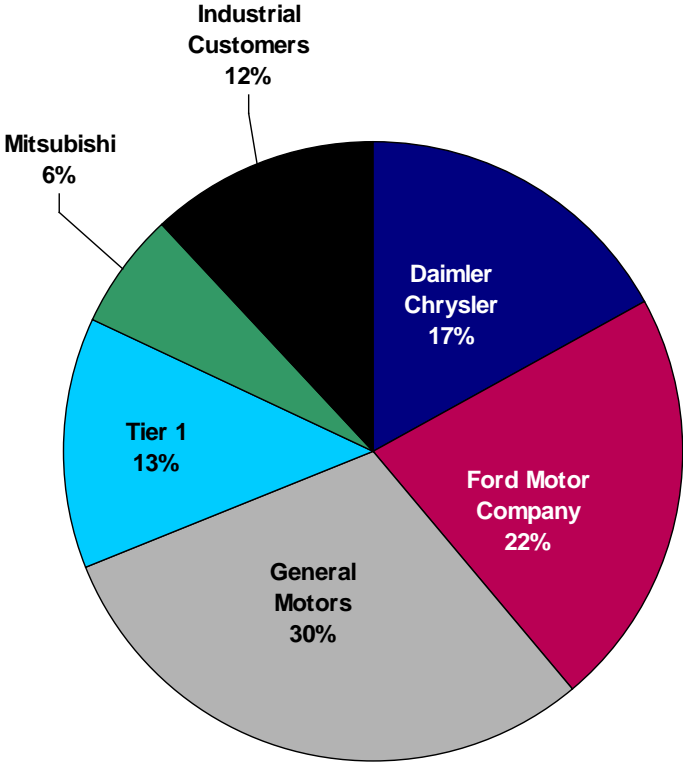

**Fiscal Year 2001**  
**Net Sales = \$203 million**

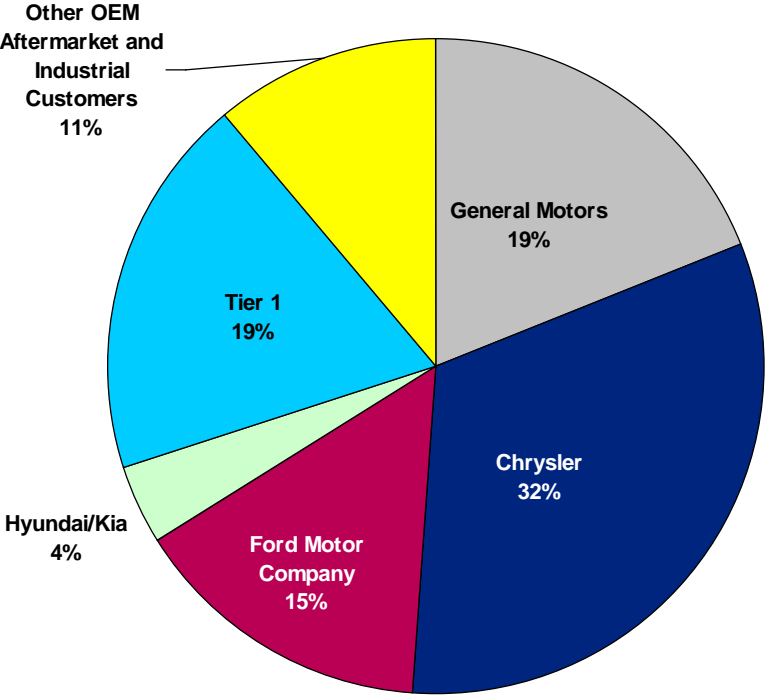

**Fiscal Year 2013**  
**Net Sales = \$298 million**

**Milwaukee, WI** - 420 Employees  
Headquarters, Engineering, Parts Manufacturing

**Juarez, Mexico** - 2,156 Employees  
2 Facilities – Assembly, Key Finishing  
& Plastic Injection Molding

**El Paso, Texas** - 30 Employees  
Distribution

**Troy, Michigan** - 57 Employees  
Sales and Engineering

# *Traditional Product:* Vehicle Lockset



## Sales (in millions of \$)

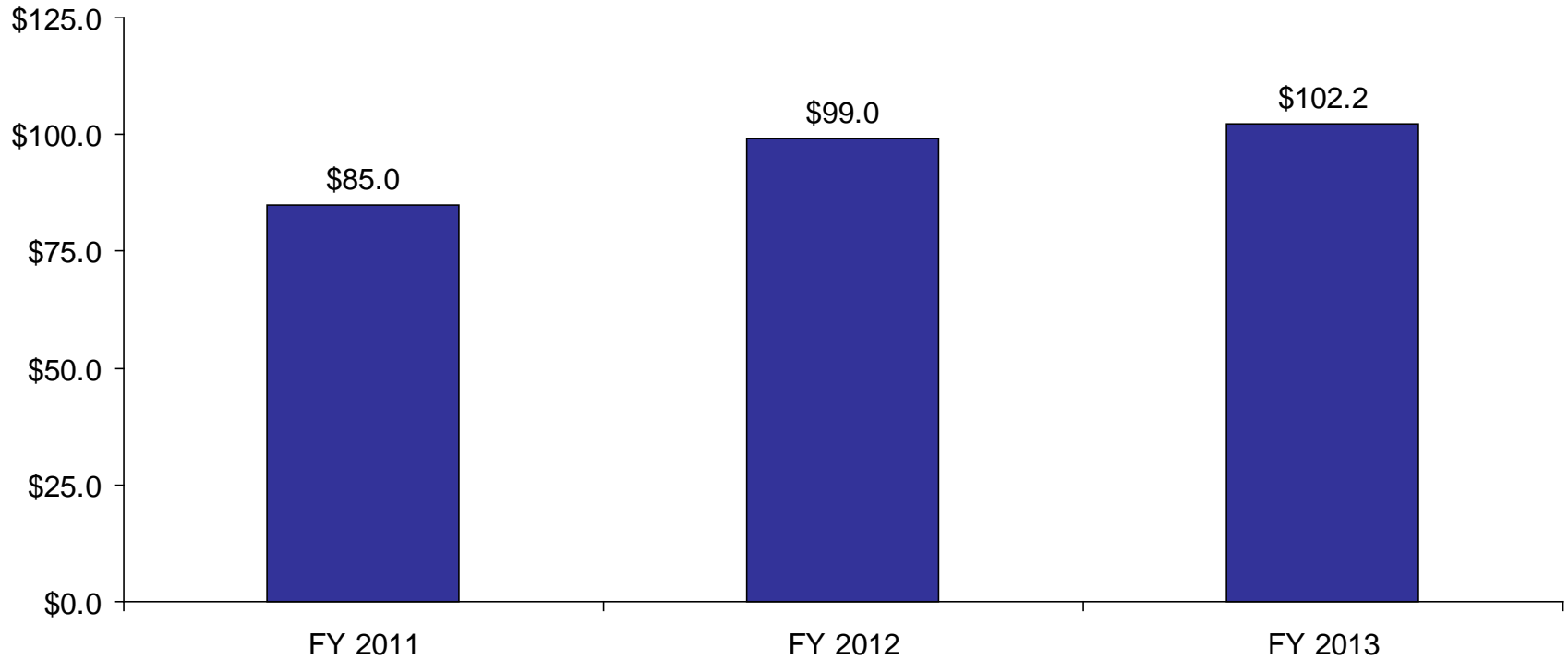

**Fiscal Year Ending June**



## Sales (in millions of \$)

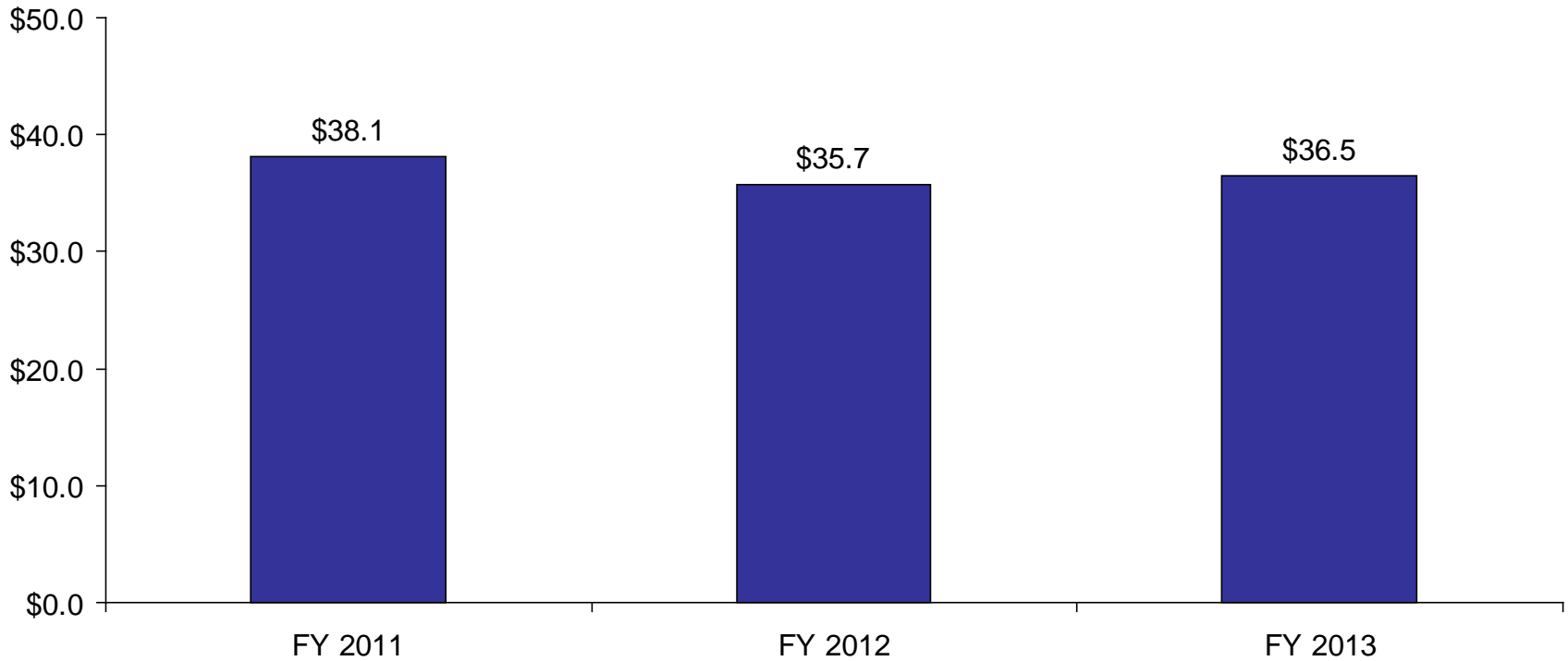

**Fiscal Year Ending June**

## Ignition Lock Housings Primarily Tier II Business

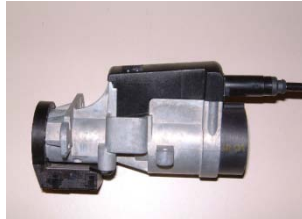

## Electronic Steering Column Lock (ESCL)

2013 GM Alpha Platform – Cadillac ATS

- First production ESCL for STRATTEC
- GM Corporate Common Component (sold directly to GM)
- Core design elements to be used in other GM ESCL applications



## Sales (in millions of \$)

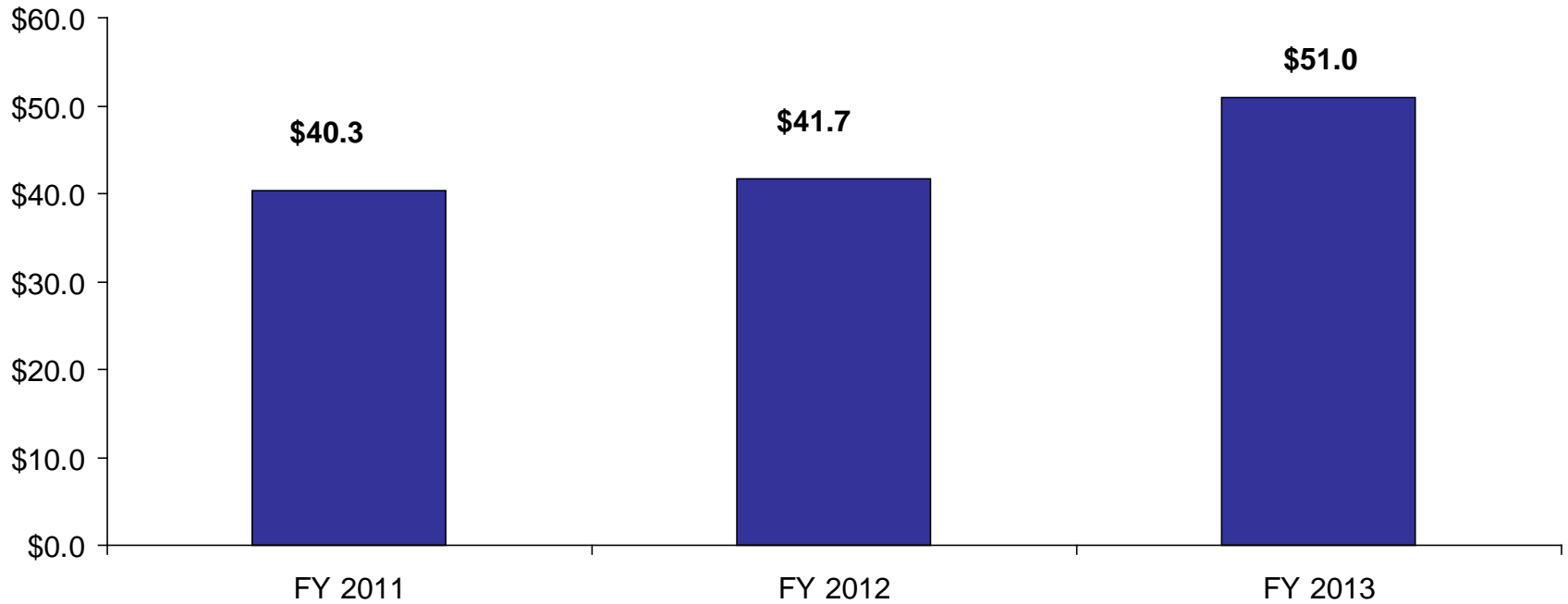

**Fiscal Year Ending June**

# Latches in Production for General Motors



Seat Back Latches



Rear Compartment Latch

2 Versions – power release, or  
power release and cinching

## Ford Business Mini-Direct Drive Decklid Latch

- Compact Power & Manual Release Latch
- 2013 CD4 Program – Ford Fusion/Lincoln MKZ

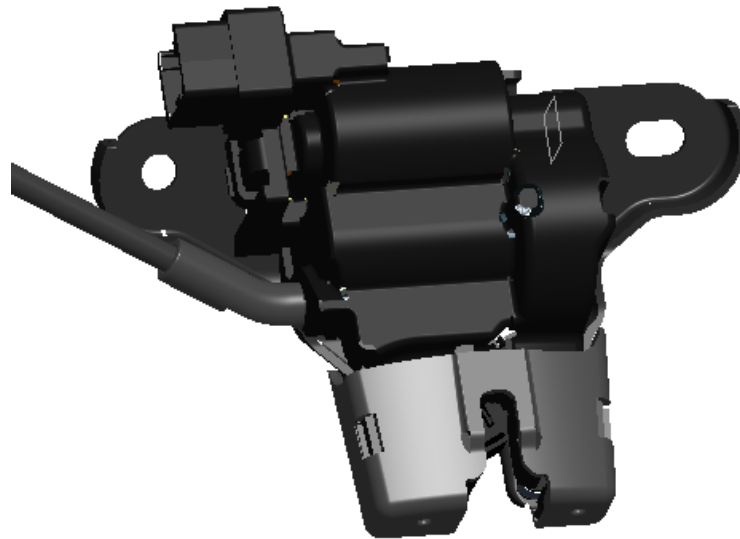

### Sales (in millions of \$)



**Fiscal Year Ending June**

# Power Access Business Overview

- **Business Acquired November 2008**
- **Global Customer Base**
- **Power Sliding Door (PSD)**
- **Power Liftgate (PLG)**
- **Power Deck Lid (PDL)**
- **Power Tonneau Cover (PTC)**
- **Power Cinching Latch & Striker**
- **Touchless Obstacle Detection**





**Sales**  
(in millions of \$)

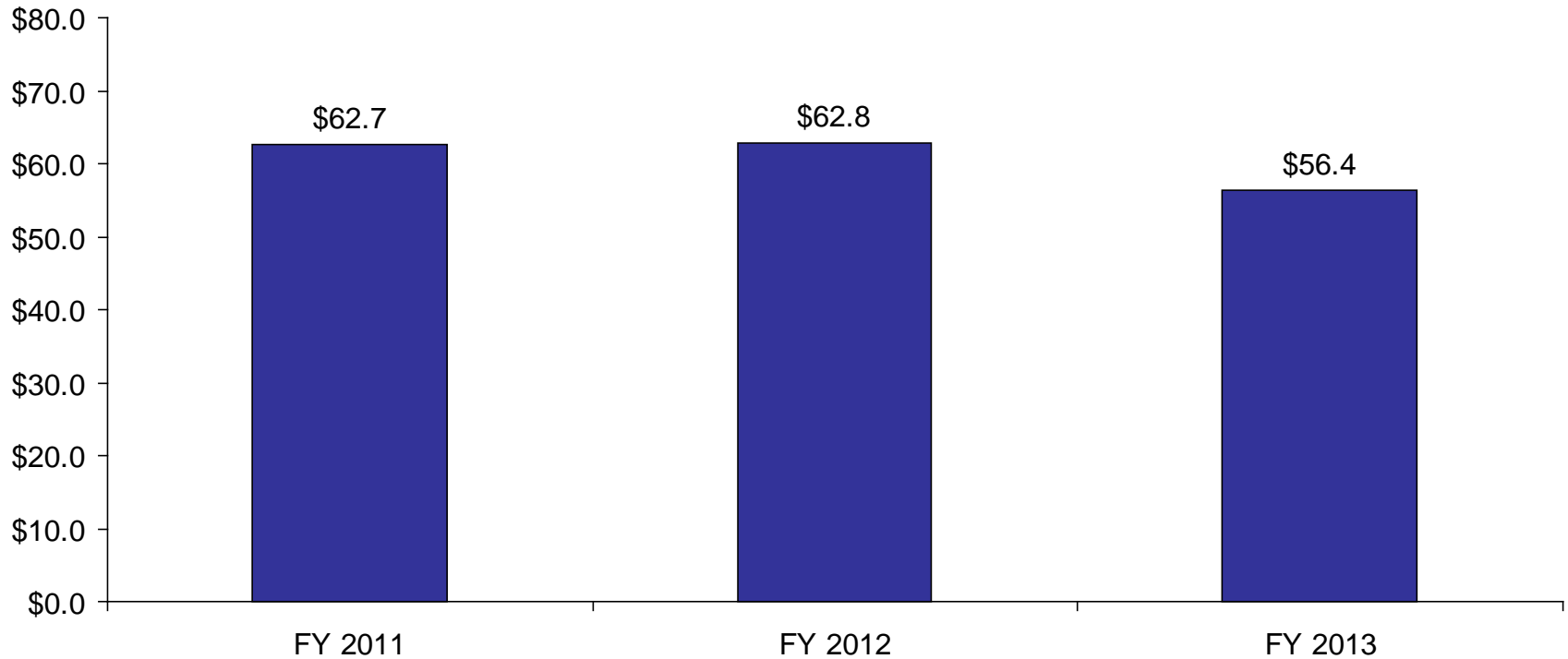

**Fiscal Year Ending June**

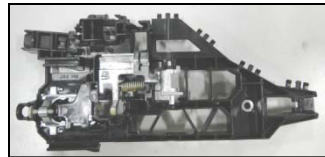
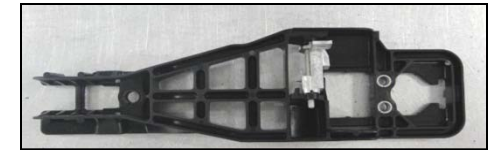
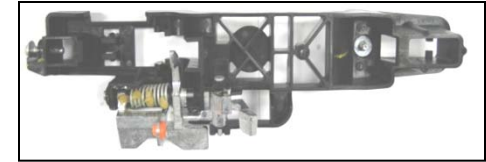
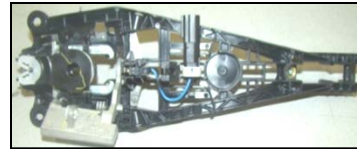

- **Joint Venture with ADAC Automotive. Plastic Injection Molding and Assembly.**
- **Established 2007**
- **Light bar with camera for rear view assist.**
- **Door Chassis and inside handles (with electrical switches and mechanical systems).**

### Sales (in millions of \$)

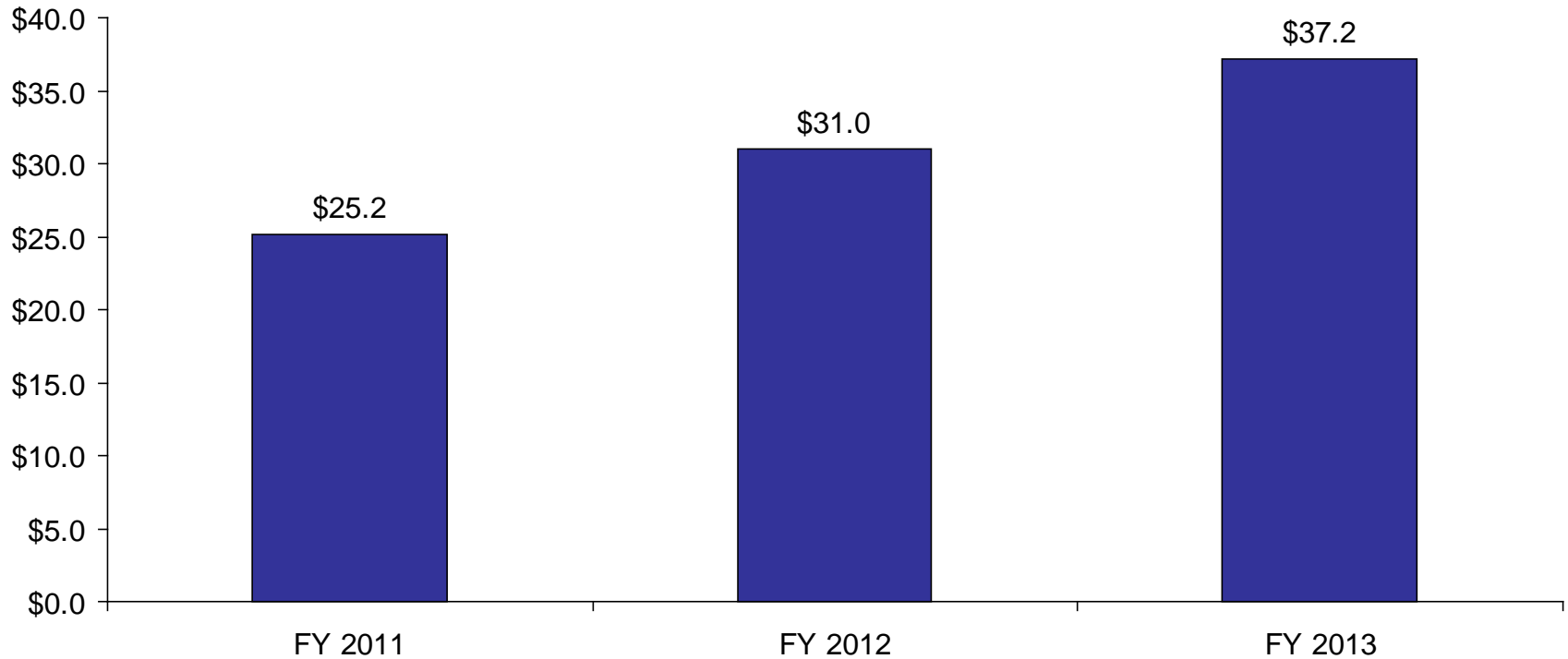

Fiscal Year Ending June



Vehicle Access Systems Technology



VEHICLE ACCESS SYSTEMS TECHNOLOGY



- **Strategic partnership:**

STRATTEC – Wisconsin – public company since 1995, founded 1908, 2663 employees

WITTE – Germany – privately held – founded 1899, 3229 employees

ADAC – Michigan – privately held – founded 1975, 1119 employees

- **Jointly own:**

VAST China – Manufacturing & Engineering

VAST Brazil - Manufacturing

VAST Japan – Sales

VAST Korea – Sales & Engineering

- **Growth opportunity:**

India

-  is the brand we are using to grow our global business

- \$1.2 billion + sales
- 16 Manufacturing facilities
- 7 Engineering Centers
- Employment over 7,700

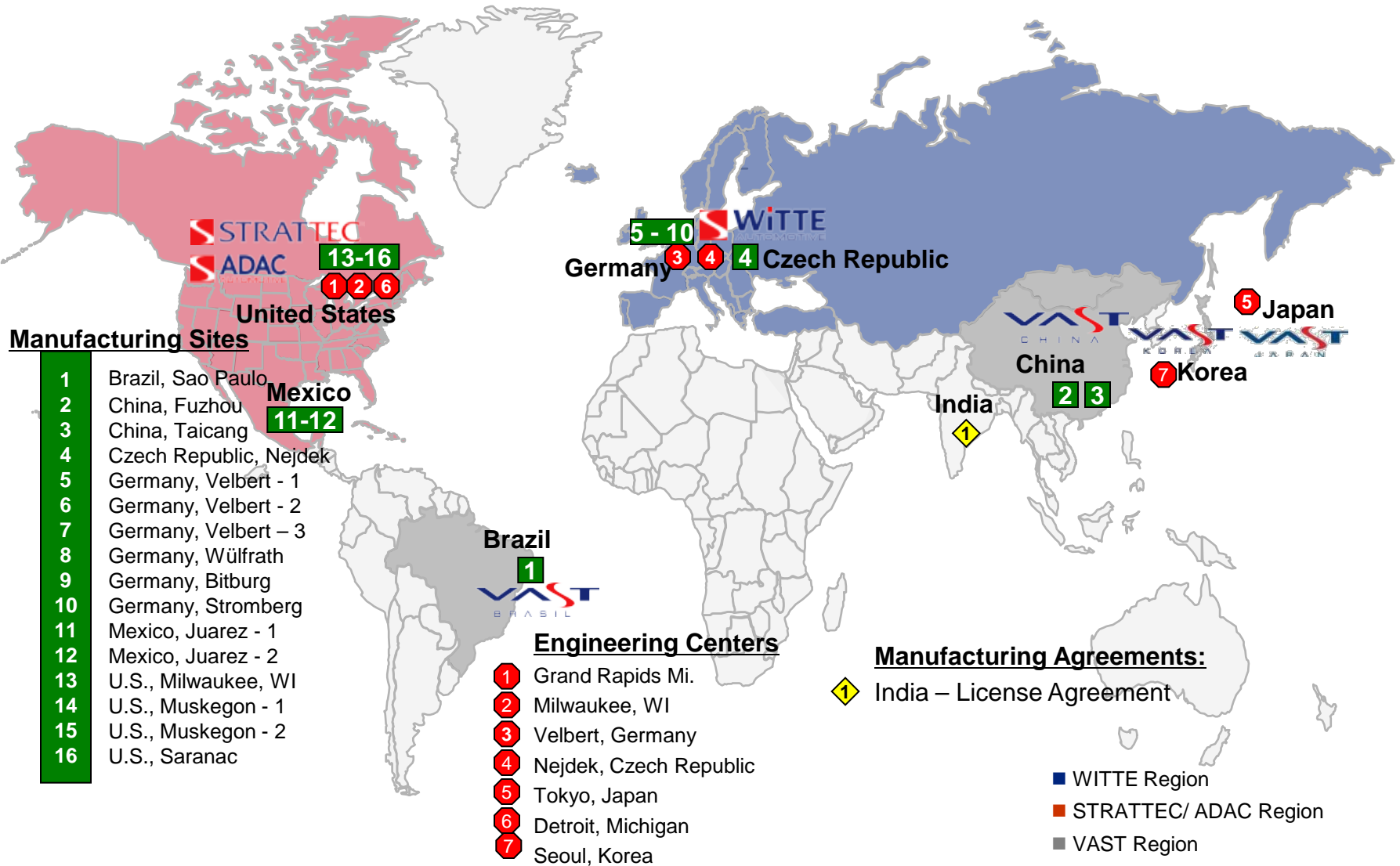



ThyssenKrupp



CHRYSLER





- Witte reorganization
- Strattec reorganization
- VAST staff expanded
- GLOBAL TEAMS
  - Purchasing
  - Manufacturing
  - Technology
  - Finance
- VAST China management changes

In Millions  
Of US Dollars

# Sales Growth

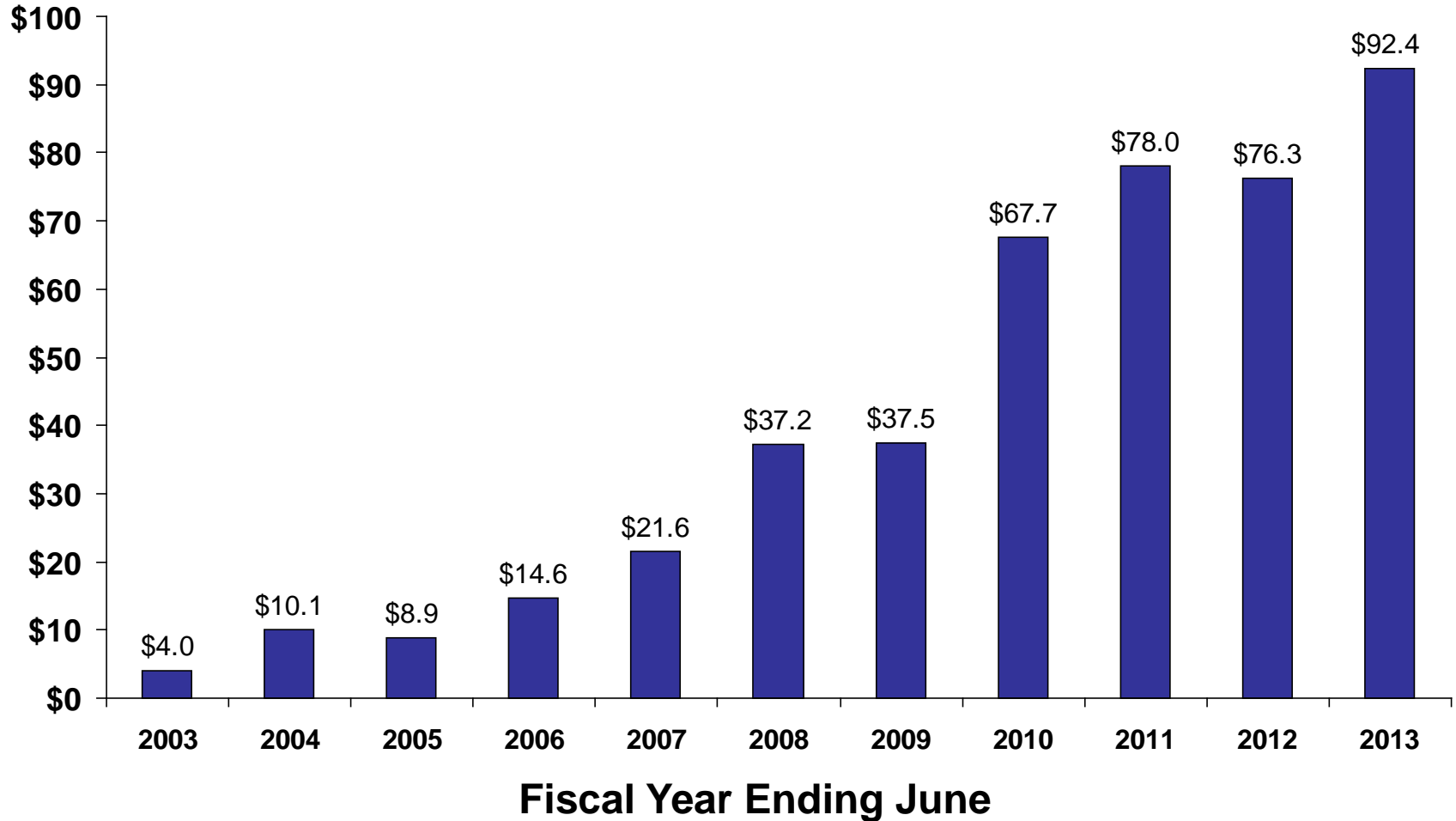

- Change in profitability
- Paint line – investment of \$5 million
  - Many start-up costs and problems
  - Turned profitable second half Strattec fiscal year 2013
  - Projected to be at capacity within 2 years

**150,000 sq. ft. manufacturing facility in Taicang, China.  
Operational September 2011.  
Second facility in Fuzhou.**



- International & Product Growth
- Strong Balance Sheet & Cash Flow
- Diversification Initiatives

# Questions?